

FÖRKLARINGAR

MÅTT I MILLIMETER

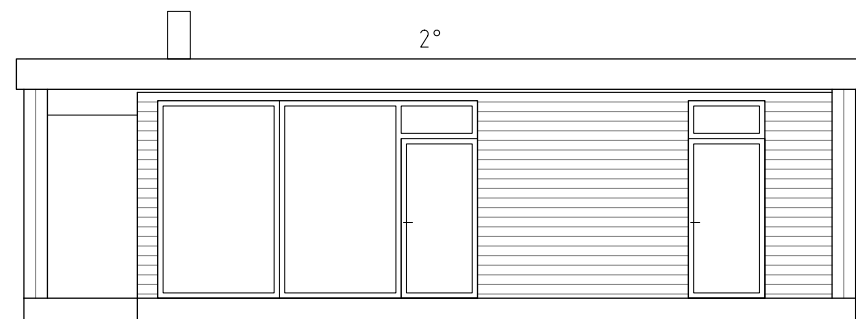

FASAD MOT SÖDER

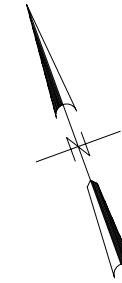
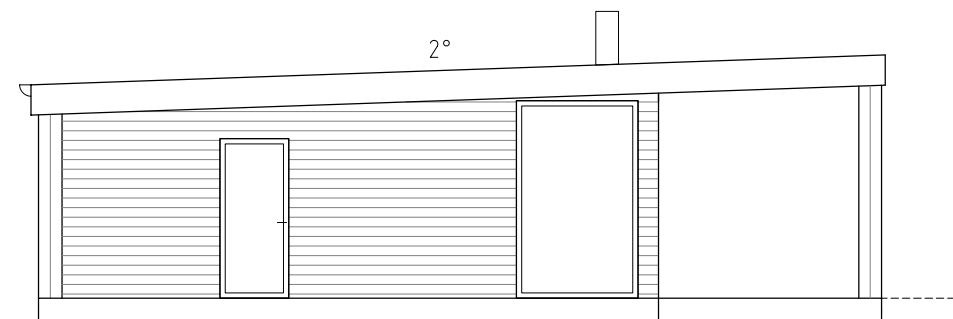

FASAD MOT VÄSTER

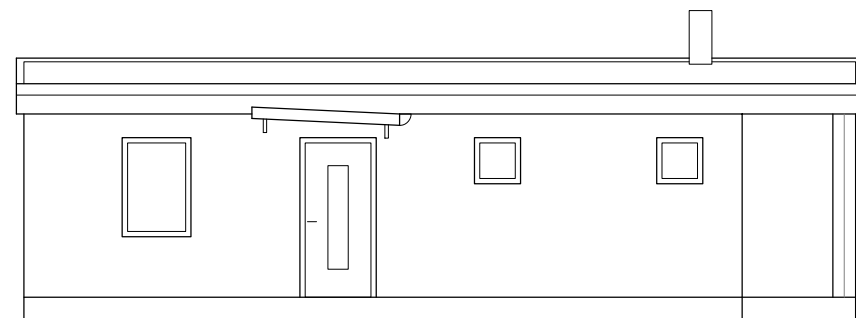

FASAD MOT NORR

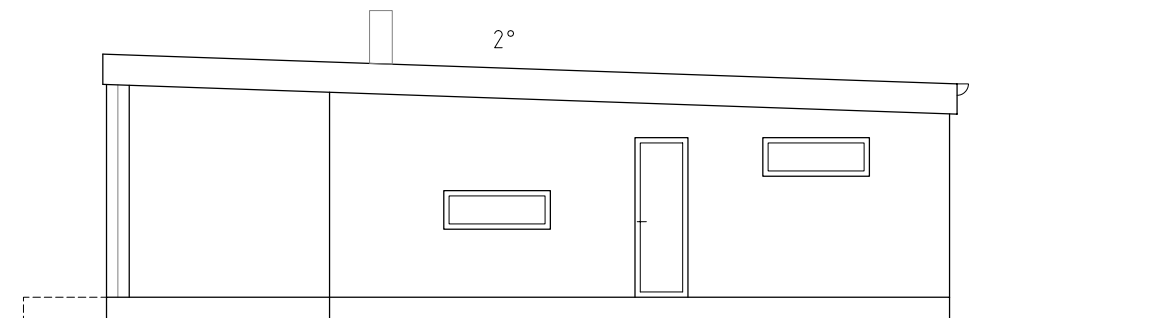

FASAD MOT ÖSTER

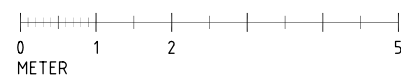
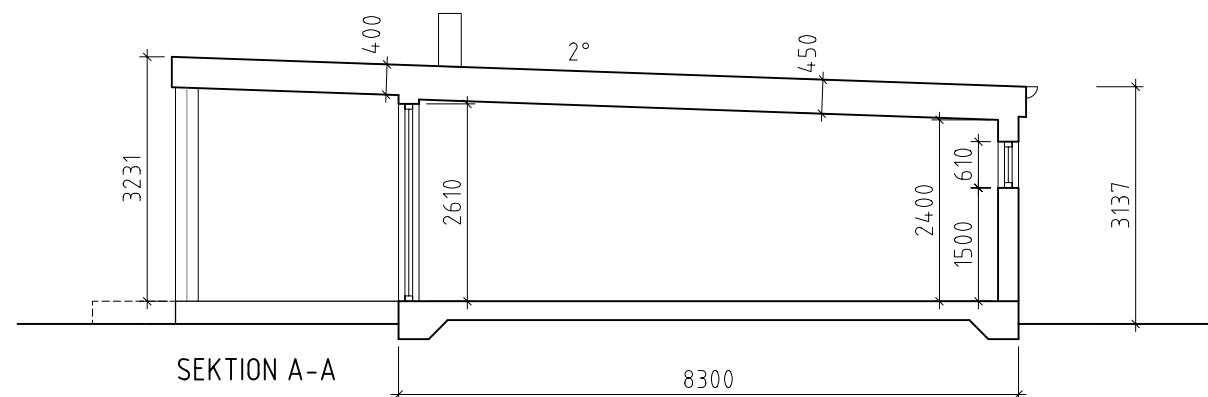
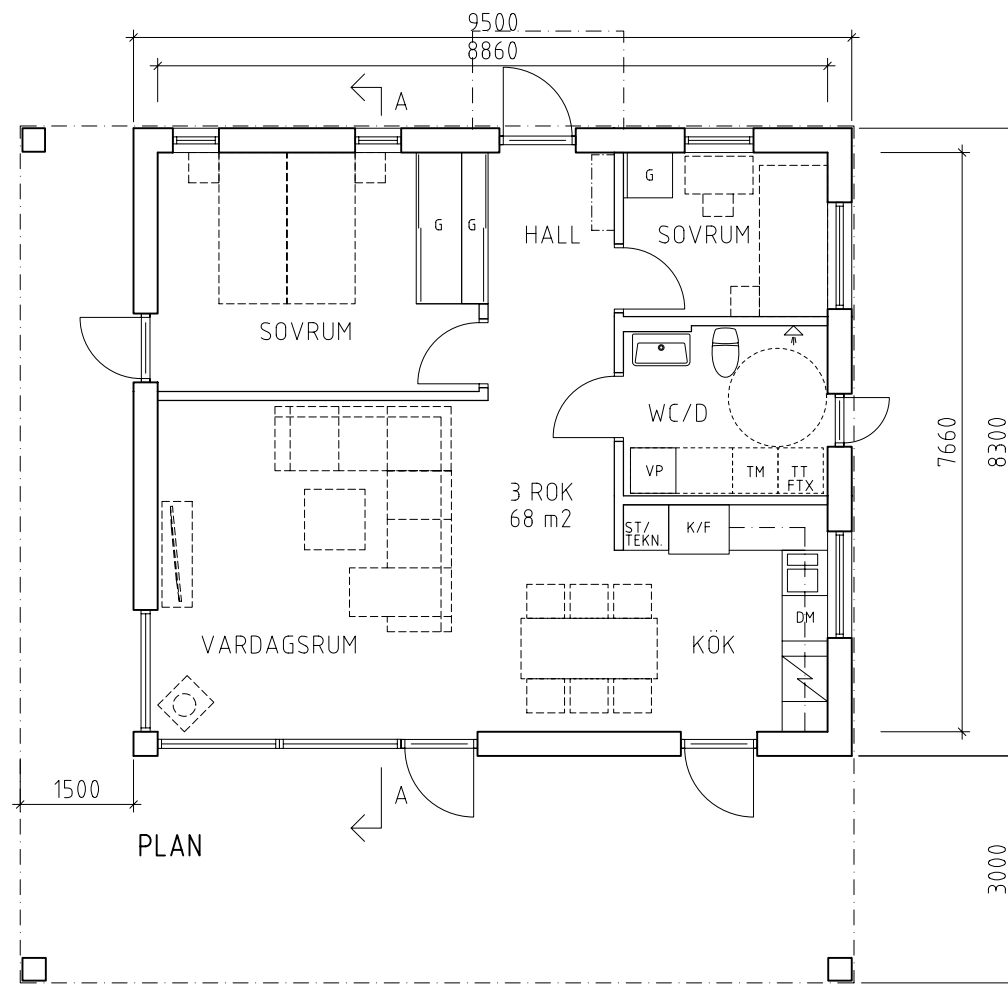

LAGER:

BET	ANT	ÄNDRINGEN AVSER	SIGN	DATUM
BYGGLOVHANDLING				
SÖRVÅGE 3:69, ÖRNSKÖLDSVIKS KOMMUN TOMT 49, VILLA MOD				
BYGGSIGURD		BYGGSIGURD AB Högbergsgatan 4 891 32 ÖRNSKÖLDSVIK 0660 - 821 20 byggsgurd@byggsgurd.se		
S8M Arkitekter		S8M Arkitekter börma till S8M Høking AB Vägsnäsavägen 119 892 92 DOMSJÖ 070 - 37 11 787 s8m@s8m.se		
UPPDRAG NR 33331502	RITAD AV SS	HANDLÄGGARE SS		
DATUM 2015-09-21	ANSVARIG Stefan Schünemann			
PLAN, SEKTION OCH FASADER				
SKALA A1 = 1:50 A3 = 1:100	NUMMER A40.14-49-02			BET